



P&Z ELECTRONICS CO.,LTD

Amorphou Common Mode Power Line Choke
 Web:<http://www.dgpinzhan.com>
 E-mail:sale@dgpinzhan.com

Part Code	Date	Production	Type	Version	Page
PZABTL1005V-102M	2018/9/5	Tom	DIP	A001	1

General Properties:

It is recommended that the temperature of the component does not exceed +125°C under worst case conditions.

Storage Temperature:	-20 °C up to +60 °C
Operating Temperature:	-40 °C up to +125 °C

Temperature Rise < 55K.

Test conditions of Electrical Properties: +20°C, 33% RH if not specified differently.

Electrical Properties:

Properties	Test conditions	Value	Unit	Tolerance
Inductance	10KHZ/0.25V	1	mH	Min
DC Resistance	@20 °C	55	mΩ	Max
Rated Current	@70 °C	2.5	A	Max
Rated Voltage(UR)	50 Hz	250	V/(AC)	Max
Insulation Test Voltage(UT)	50 Hz/ 5 mA/ 3 sec.	1500	V/(AC)	Pass

Dimensions: [mm]

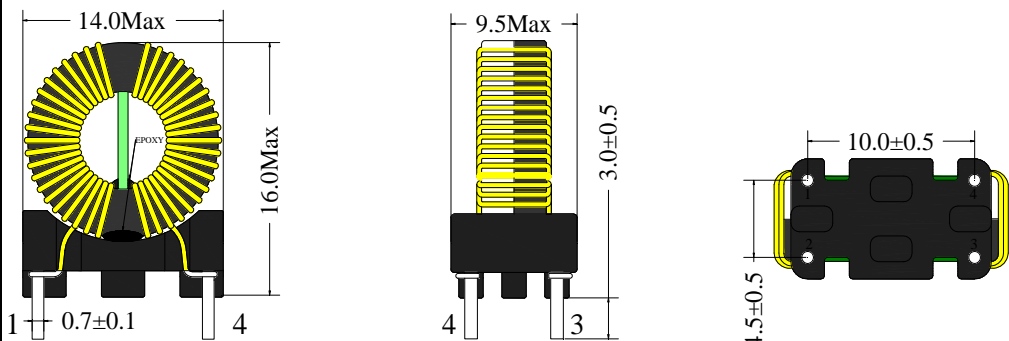

Schematic:

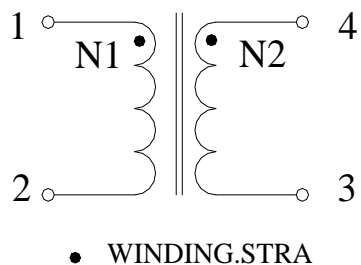

PCB Layout Ref(mm)

